

HITEN 104 LITHIUM-ION BATTERY PACK SPECIFICATION

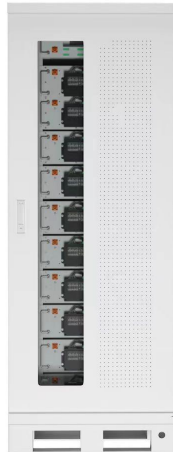

CONTENT

1. Introduction	1
2. Function	1
3. Product detail information	2
3.1 High voltage box module	2
3.2 Electrical schematic diagram	6
3.3 Battery box dimensions	6
3.4 Battery parameters	7
3.4 Battery protection parameter	9
3.5 CAN Communication	12
3.6 RS485 communication	12
3.7 Automatically coding	12
4 Working mode	13
4.1 Charging mode	13
4.2 Discharge mode	13
4.3 Standby mode	13
4.4 Turn off and wake up	13
5 SYSTEM WIRING	14
5.1 Main circuit wiring	14
5.2 Communication wiring	14
5.3 Power-on	15
5.4 Parallel expansion	15
6 Installation and commissioning	16
6.1 List	16
6.2 List	17
7.Package	18
8.Safety precaution	19

1. Introduction

This battery system is suitable for home energy storage and small and medium-sized commercial storage battery systems. It uses 3.2V 104AH lithium cells to form a 16-string battery module and intelligent BMS to form a lithium battery system. The system supports up to 16 batteries in series. This system is prohibited from mixed connection and use with other batteries of different brands and models.

2. Function

- 1) Reliable charge and discharge. Efficient charging and discharging through lithium iron phosphate batteries, long service life and high reliability.
- 2) Automatic protection function. Quick response, high-precision data sampling, and complete and reliable protection function:
 - Overall battery pack over voltage and under voltage protection, single battery cell over voltage and under voltage protection;
 - Charge and discharge over current protection;
 - Charge and discharge over temperature protection;
 - Short-circuit protection;
- 3) Protection reset mode. When the battery pack or cell is under overcharge protection, the voltage returns to the overcharge reset voltage value, and the over current or over discharge protection is automatically reset.
- 4) Battery balancing function. Balance control is performed based on the voltage of each cell, passive discharge balancing method.
- 5) Run historical event storage function.
- 6) The upper computer software control function allows you to protect parameters such as overcharge, over discharge, charge and discharge over current, over temperature and under temperature. Setting parameters such as capacity, sleep, balance and storage.
- 7) RS485, RS232 communication function with screen monitoring display.
- 8) CAN communication function, adopts isolated communication and support automatic address encoding or address dialing function.

3. Product detail information

3.1 High voltage box module

3.1.1 High voltage box appearance and structural dimensions

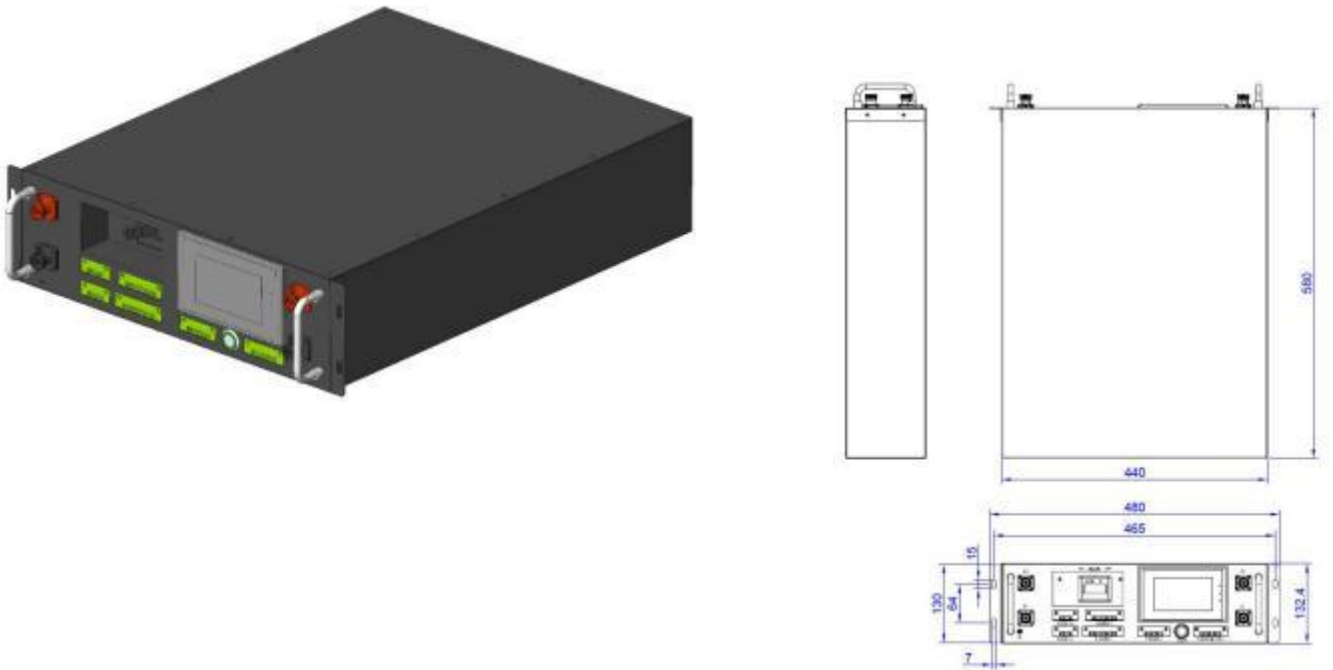

3.1.1 - 1 High voltage box appearance dimension drawing

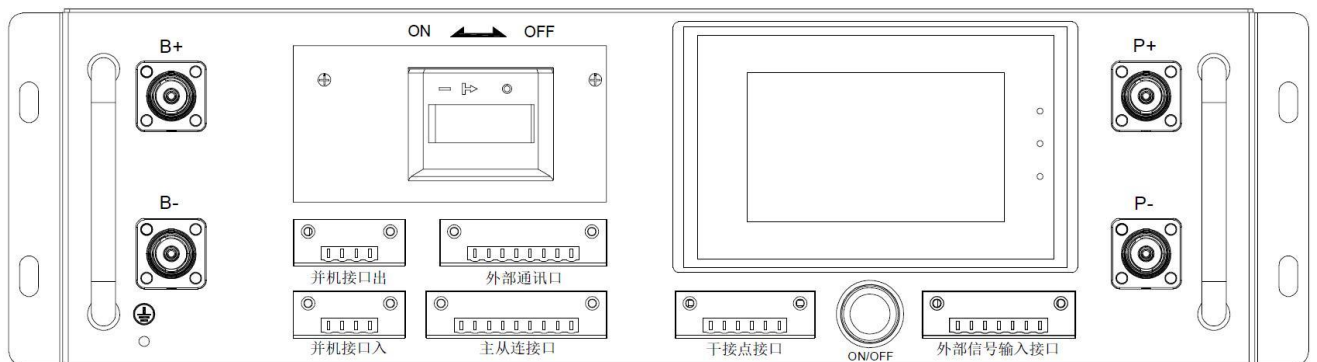

3.2.2 Panel interface diagram

HITEN 104 Lithium-ion battery pack

3.1.2 Interface definition

Dry contact interface					
NO	PIN definition	Instruction	NO	PIN definition	Instruction
1	RLY-OUT1+	Dry contact 1 output positive terminal	4	RLY-OUT2-	Dry contact 2 output negative terminal
2	RLY-OUT1-	Dry contact 1 output negative terminal	5	NC	Vacant
3	RLY-OUT2+	Dry contact 2 output positive terminal	6	NC	Vacant

External signal input interface					
NO	PIN definition	Instruction	NO	PIN definition	Instruction
1	5VO	Output DC5V/1A	5	SIN1-	Input detection1
2	5V_GND	Output DC5V/1A	6	SIN2+	Input detection2
3	DOPWM	Output PWM	7	SIN2-	Input detection2
4	SIN1+	Input detection1			

Parallel output interface					
NO	PIN definition	Instruction	NO	PIN definition	Instruction
1	ADDR_out	Local CAN code output	3	CAN-H2	Local CAN communication
2	CAN-L2	Local CAN communication	4	CAN-GND	CAN communication ground

Parallel input interface					
NO	PIN definition	Instruction	NO	PIN definition	Instruction
1	ADDR_IN	Local CAN code input	3	CAN-H2	Local CAN communication
2	CAN-L2	Local CAN communication	4	CAN-GND	CAN communication ground

HITEN 104 Lithium-ion battery pack

External communication interface					
NO	PIN definition	Instruction	NO	PIN definition	Instruction
1	RS485-A1	Local 485 communication	5	RS485-A3	Reserve 485 communication
2	RS485-B1	Local 485 communication	6	RS485-B3	Reserve 485 communication
3	GND_A1	485_A1communication location	7	CAN-L3	Communicate with PCS
4	GND_A3	Reserve 485_A3 communication location	8	CAN-H3	Communicate with PCS

Master-slave connection port					
NO	PIN definition	Instruction	NO	PIN definition	Instruction
1	VO	Slave control power supply output positive (BMU)	6	DC24V+	24V power input positive pole
2	CAN-L1	Slave control CAN communication (BMU)	7	DC24V-	24V power input negative pole
3	CAN-H1	Slave control CAN communication (BMU)	8	DC24V+	24V power input positive pole
4	PGND	Slave control power supply output negative (BMU)	9	DC24V-	24V power input negative pole
5	DN-OP	Slave control code output			

3.1.3 BCU Main technology parameters

Technology parameters		
Applicable platforms	<1000V	
Supply voltage	12-30V	
Power consumption	Rated power consumption	<3W
	Static power	0
Total voltage sampling	Sampling range	50~1650V
	Sampling Accuracy	±0.3%FSR
Current sampling	Sampling range	<300A (default shunt) / >300A (Hall)
	Sampling Accuracy	0.5%
	Sampling cycle	20ms
	Sampling range	-40~125℃
	Sampling Accuracy	±2℃

HITEN 104 Lithium-ion battery pack

Temperature sampling	Sampling cycle	200ms	
	Sampling channels	5 way	
Insulation testing	Range	>1MΩ/kV	
	Accuracy	>100K 10%、<100K 15%、Min 10K,<2MΩ treated es fault	
Status estimate	SOC	≤5%	
	SOH	≤10%	
Communication interface	CAN-1	Slave control (125k ~1000kbps) , default baud rate : 250K	
	CAN-2	Cluster parallel machine (125k ~1000kbps) , default baud rate : 500K	
	CAN-3	Connect PCS , baud rate based on the protocol provided by customer	
	RS485-1	Host computer (9600~115200bps) , default baud rate : 57600	
	RS485-2	Display (9600~115200bps) , default baud rate : 9600	
	RS485-3	Reserve	
Relay adhesion testing	Fault diagnosis	CAN matching resistor	External
DOH	-	Automatic coding	Support/with coding line
DOL	6 pic	Data storage	128M
DO output range	Depending on supply voltage	Working temperature range	-40~85℃
DO output current	-	Working humidity range	5~90%
Dry contact	2 pic	DI testing (12V withstand voltage)	2 way DI , External stem node signal (High voltage interlock,emergency stop)
Dry contact Max. Power withstand	Max power withstand 60W	Installation method	Wall hanging

HITEN 104 Lithium-ion battery pack

3.2 Electrical schematic diagram

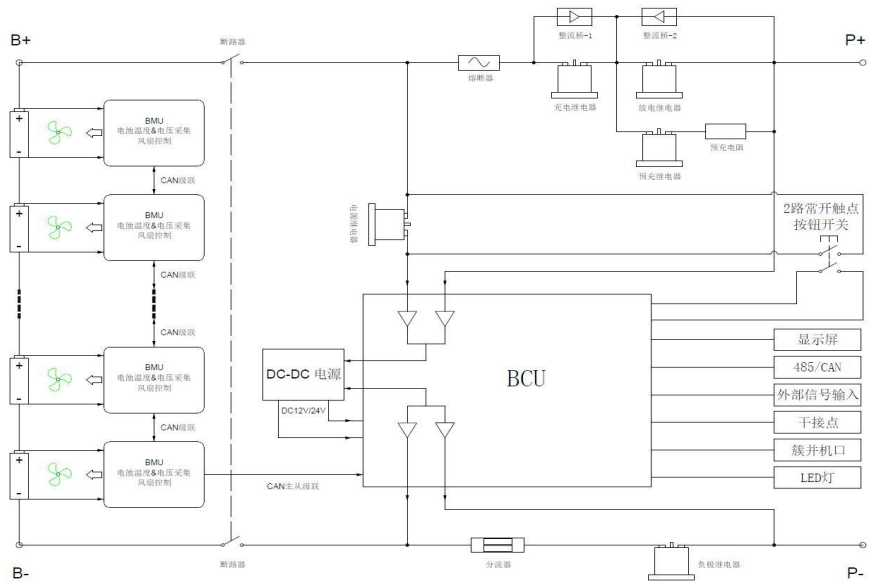

3.3 Battery box dimensions

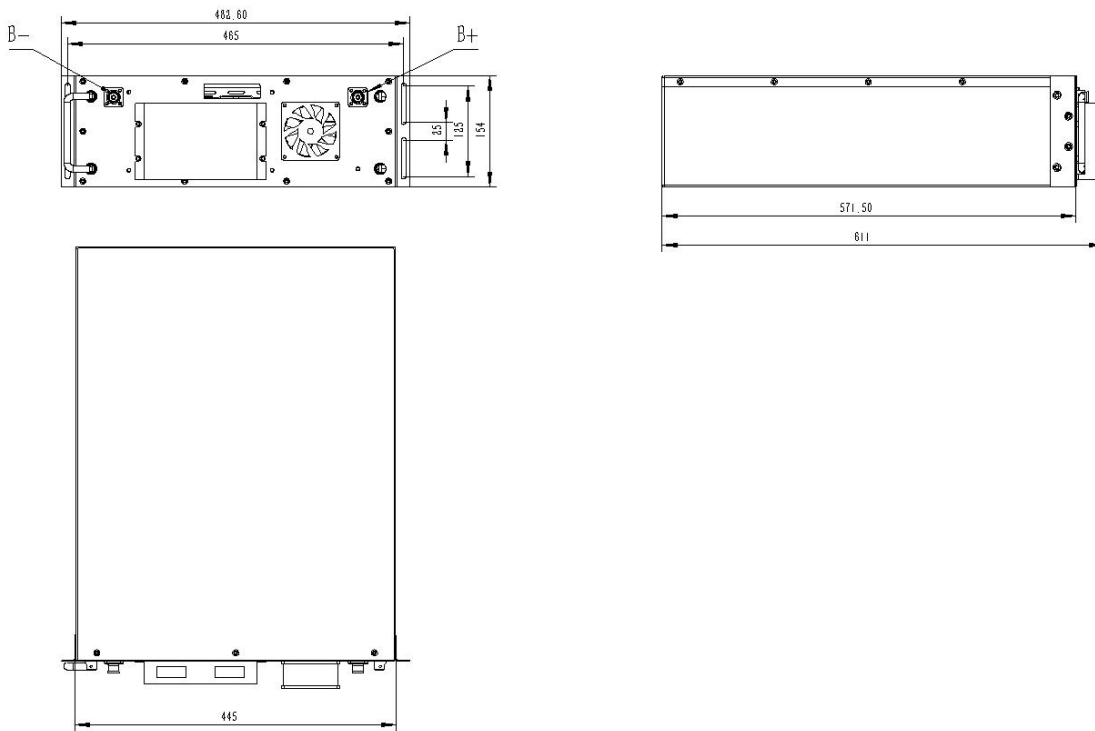

HITEN 104 Lithium-ion battery pack

3.4 Battery parameters

Item	HV-AC-S7	HV-AC-S8	HV-AC-S9	HV-AC-S10	HV-AC-S11
Rated capacity(kWh)	37.38 kWh	42.59kWh	47.88 kWh	53.2kWh	58.5kWh
Battery type	LFP	LFP	LFP	LFP	LFP
Configuration	7*16S1P	8*16S1P	9*16S1P	10*16S1P	11*16S1P
Rated voltage(V)	358.4V	409.6V	460.8V	512V	563.2V
Rated capacity(Ah)	104Ah	104Ah	104Ah	104Ah	104Ah
Working voltage range(V)	280V-408.8V	320-459.9V	360-526.6V	432-584V	440-642.4V
Rated charge and discharge current(A)	100A	100A	100A	100A	100A
Rated charge and discharge power(kW)	35 kW	40kW	46 kW	51 kW	56 kW
Communication	CAN/RS485	CAN/RS485	CAN/RS485	CAN/RS485	CAN/RS485
Cycle (time)	5000	5000	5000	5000	5000
Working temperature range(°C)	-15-45	-15-45	-15-45	-15-45	-15-45
Humidity(%)	5%-65%	5%-65%	5%-65%	5%-65%	5%-65%
Altitude(m) Use beyond derating	2000m	2000m	2000m	2000m	2000m

HITEN 104 Lithium-ion battery pack

Item	HV-AC-S12	HV-AC-S13	HV-AC-S14	HV-AC-S15	HV-AC-S16
Rated capacity(kWh)	63.89 kWh	69.22kWh	74.54 kWh	79.87kWh	85.19kWh
Battery type	LFP	LFP	LFP	LFP	LFP
Configuration	12*16S1P	13*16S1P	14*16S1P	15*16S1P	16*16S1P
Rated voltage(V)	614.4V	665.6V	716.8V	768V	819.2V
Rated capacity(Ah)	104Ah	104Ah	104Ah	104Ah	104Ah
Working voltage range(V)	480V-700.8V	520-759.2V	560-817.6V	600-876V	640-934.4V
Rated charge and discharge current(A)	100A	100A	100A	100A	100A
Rated charge and discharge power(kW)	61kW	66 kW	71 kW	76 kW	81kW
Communication	CAN/RS485	CAN/RS485	CAN/RS485	CAN/RS485	CAN/RS485
Cycle (time)	5000	5000	5000	5000	5000
Working temperature range(°C)	-15-45	-15-45	-15-45	-15-45	-15-45
Humidity(%)	5%-65%	5%-65%	5%-65%	5%-65%	5%-65%
Altitude(m) Use beyond derating	2000m	2000m	2000m	2000m	2000m

HITEN 104 Lithium-ion battery pack

3.4 Battery protection parameter

NO	ITEM		Default parameters	WHETHER Configurable	REMARK
1	Monomer overcharge protection	Cell overcharge alarm voltage	3550mV	Configurable	
		Cell overcharge protection voltage	3600mV	Configurable	
		Cell overcharge protection delay	1.0S	Configurable	
	Monomer overvoltage protection release	Cell overcharge protection release voltage	3380mV	Configurable	
		Capacity release	SOC<96%	Configurable	
		Discharge release	Discharge current>1.0A		
2	Monomer overdischarge protection	Cell overcharge alarm voltage	2800mV	Configurable	After overdischarge protection 30s, if recovery still not possible,the system automatically shuts down
		Cell overcharge protection voltage	2500mV	Configurable	
		Cell overcharge protection delay	1.0S	Configurable	
	Monomer overcharge protection release	Cell overcharge protection release voltage	2900mV	Configurable	
		Release when charging	Activated by plugging in a charger		
3	Total overcharge protection	Overcharge alarm voltage	112V	Configurable: monomer*32S/box	
		Overcharge protection voltage	115.2V	Configurable: monomer*32S/box	
		Overcharge protection delay	1.0S	Configurable	
	Total overvoltage Protection release	Overcharge protection release voltage	108.16V	Configurable: monomer*32S/box	
		Capacity release	SOC<96%	Configurable	
		Discharge release	Discharge current >1.0A		
4	Total overdischarge protection	Overcharge alarm voltage	89.6V	Configurable: monomer*32S/box	
		Overcharge protection voltage	86.4V	Configurable: monomer*32S/box	
		Overcharge protection delay	1.0S	Configurable	
	Total overdischarge protection release	Cell overcharge protection release voltage	92.8V	Configurable: monomer*32S/box	
		Release when charging	Activated by plugging in a charger		

HITEN 104 Lithium-ion battery pack

5	Charging overcurrent protection	Overcurrent alarm	52A		This state will be locked and will no longer be automatically released if it appears 10 times in a row
		Overcurrent protection	55A		
		Overcurrent protection delay	5.0S		
	Charging overcurrent protection release	Automatically release	After 1min automatically release		
		Discharge release	Discharge current >1.0A		
7	Discharge overcurrent 1 protection	Overcurrent 1 alarm current	52A		This state will be locked and will no longer be automatically released if it appears 10 times in a row
		Overcurrent1 protection current	55A		
		Overcurrent1 protection relay	5.0S		
	Discharge overcurrent 1 protection release	Automatically release	After 1min automatically release		
		charge release	Charging current >1.0A		
8	Discharge overcurrent 2	Overcurrent2 protection current	≥90A		This state will be locked and will no longer be automatically released if it appears 10 times in a row
		Overcurrent 2 protection relay	500mS		
	Discharge overcurrent 2 protection release	Automatically release	After 1min automatically release		
		charge release	Charging current >1.0A		
9	Cell temperature protection	Charging low temperature alarm	2°C		
		Charging low temperature protection	0°C		
		Charging low temperature protection release	5°C	Configurable	
		Charging high temperature alarm	50°C	Configurable	
		Charging high temperature protection	55°C	Configurable	
		Charging high temperature protection release	50°C	Configurable	

HITEN 104 Lithium-ion battery pack

		discharging low temperature alarm	-15℃	Configurable	
		discharging low temperature protection	-20℃	Configurable	
		discharging low temperature protection release	-15℃	Configurable	
		discharging high temperature alarm	55℃	Configurable	
		discharging high temperature protection	60℃	Configurable	
		discharging high temperature protection release	55℃	Configurable	
10	Environment temperature alarm	Low temperature alarm	-20℃	Configurable	
		High temperature alarm	65℃	Configurable	
11	Current consumption	Self-consumption current during operation	≤50mA (not include relay drive current)		
		Turn off mode current	NO		
12	Fan control	Turn on condition	NC		
		Turn off condition	NC		
13	Balance function	Balanced turn on voltage	3400mV	Configurable	
		Open voltage difference	30mV	Configurable	
14	Capacity default settings	Low battery alarm threshold	SOC<5%	Configurable	Not alarm when charging
15	Cell failure protection	Voltage difference	Voltage difference > 1V	Can not Configurable	Not allow to charge and discharge current
16	Full of judgment	Full charging voltage	>560V	Configurable: 3.5V*total string	Stop charging when both are satisfied, and update SOC to 100%
		Cut-off current	<1A	Configurable	

3.5 CAN Communication

CAN communication protocol compatible with the following brands:

SOFAR	Goodwe	GROWATT	DEYE	Afore
				

3.6 RS485 communication

BMS can communicate with the upper computer through the RS485 interface, thereby viewing various battery information on the host computer, including battery voltage, current, temperature, status, SOC, SOH and battery production information, etc.

The default baud rate is 57600bps;

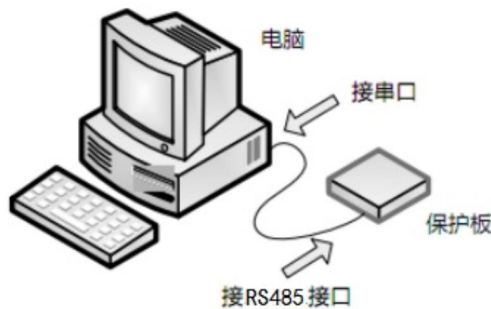

3.7 Automatically coding

When the battery modules are connected in series and the slave boards on each module perform cascade communication; or when the battery packs are connected in parallel and the main board performs parallel communications, the system will automatically encode.

The coding between slave boards can also be configured through software, and the coding will be automatically performed according to the wiring sequence. The direction of the superior connection to the main board will automatically determine the sequence. The instructions are as follows:

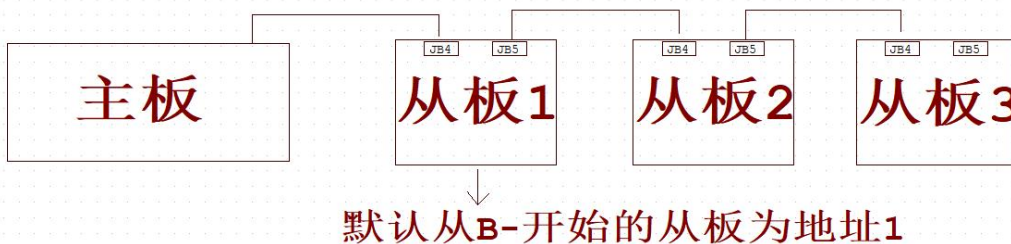

4 Working mode

4.1 Charging mode

BMS start charging when it detects that the charger is connected and the external charging voltage is greater than the internal battery voltage by more than 0.5V. When the charging current reaches the effective charging current, it enters the charging mode.

4.2 Discharge mode

The BMS enters the discharge mode when it detects that the load is connected and the discharge current reaches the effective discharge current.

4.3 Standby mode

When the above two modes are not satisfied, it enters standby mode.

4.4 Turn off and wake up

4.4.1 Turn off

When any of the following conditions is met, the system enters shutdown mode (it can only be shutdown when there is no external):

- 1) Single or overall over-discharge protection has not been released within 30 seconds.
- 2) Shut down after long pressing the button (3S).

Before entering hibernation, make sure that no charger is connected, otherwise it will not be able to enter low power mode.

4.4.2 Wake up

When the system is in shutdown mode and any of the following conditions are met, the system will exit shutdown mode and enter normal operating mode:

- 1) Connect to the charger, the charger output voltage must be greater than 300V.
- 2) Restart the system via the start button (3S).

5 SYSTEM WIRING

5.1 Main circuit wiring

Connect the positive and negative poles of the battery box and main control box as shown in the figure (do not reverse the positive and negative poles, as it will cause a short circuit of the battery, burn the plug-in and damage the battery)

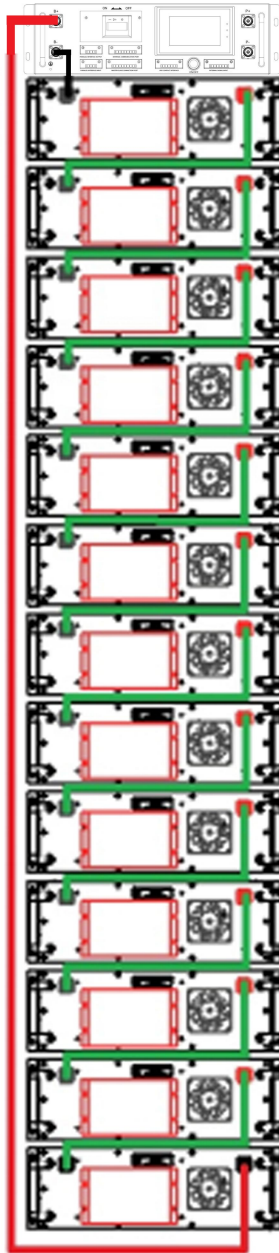

5.2 Communication wiring

The total negative BMU of the battery box is connected to the communication port of the main

control box. The communication line is connected in sequence from the total negative BMU of the battery box to the total positive BMU of the battery box.

5.3 Power-on

After using a voltmeter to check that the total battery voltage is normal, check again whether the main circuit wiring and communication wiring are correct. After confirming that they are correct, close the circuit breaker to the ON position and turn on the weak current switch of the main control box. Wait for about a minute. After checking that the display data is normal and there is no error message, the system connection is correct and the system can be powered on and loaded normally.

5.4 Parallel expansion

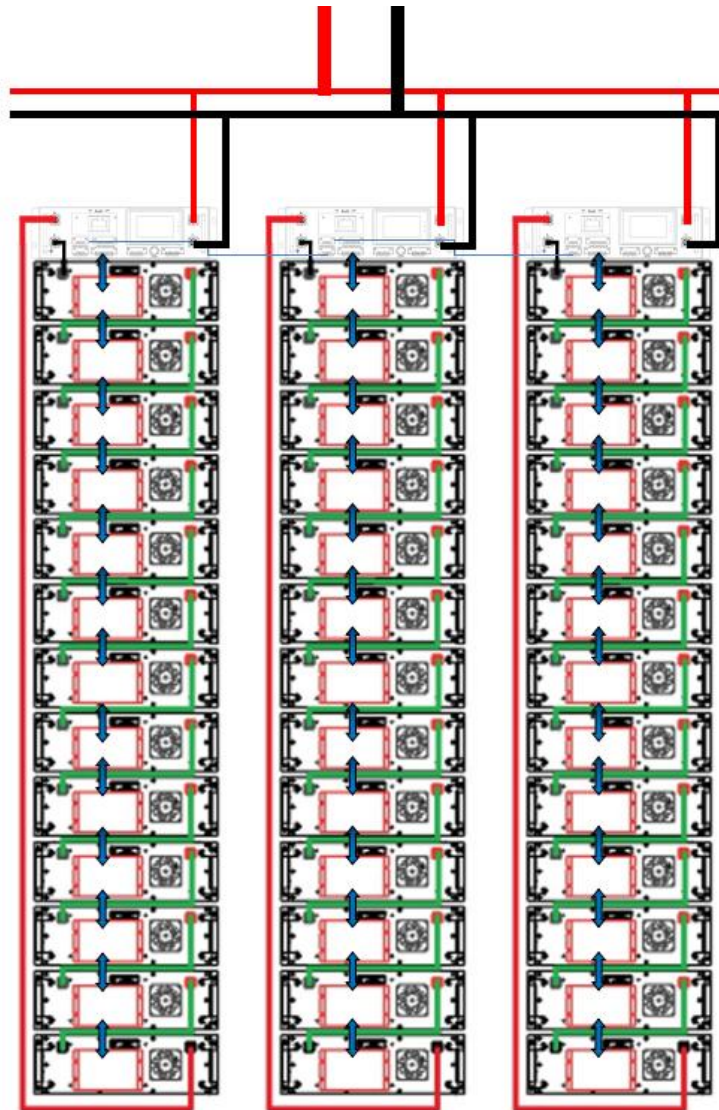

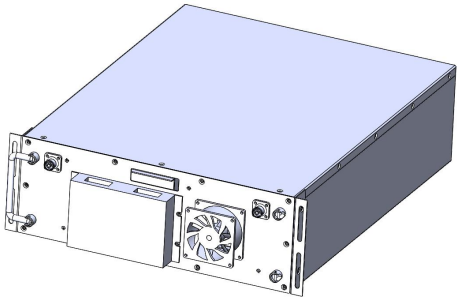

6 Installation and commissioning

6.1 List

NO	NAME	QUANTITY	PICTURE
1.	MAIN CONTROL BOX	1 PCS	
2.	BATTERY BOX	SEVERAL	

HITEN 104 Lithium-ion battery pack

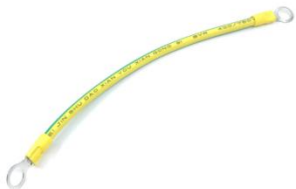
6.2 List

NO	NAME	QUANTITY	PICTURE
1.	Cabinet (optional)	1	
2.	Series line	Several (quantity depends on the number of the battery boxes)	
3.	Ground wire	Several (quantity depends on the number of the battery boxes)	
4.	Communication line	Several (quantity depends on the number of the battery boxes)	
5.	2.0m power line	1PIC	
6.	External communication line	1PIC	

7.Package

Packed in a dry,dust proof and moisture-proof packing box.

The products shall be packed with plastics film/EPE and packed in cartons.

Battery box specification: L 0.7m*W0.5m*H 0.22m Weight: 48kg

Main control box specification: L 0.78m*W0.5m*H 0.21m Weight: 25kg



8.Safety precaution

- Don't use the pack if there's any deformation.
- Do not stack up the battery.
- Please be notice the polarity of the battery and port.
- Make sure the insulation of the equipment,use the tool and instrument correctly.
- The installation site should stay away from fire and inflammable,keep ventilating and dry.
- Do not disconnect the battery terminals when its running.
- Not allow non-technology staff to open all of function module.
- Please fully charge a new battery pack,or a long-time-no-use battery pack with a designed charger.
- Do not uninstall,open,extrude,bend,impale or break the battery.
- Do not refit the battery or connect to other object,do not immerse the battery into any water,sea water,or drinks and other liquids.Stay away from fire,explosive material or other dangerous item.
- Do not allow the battery short circuit,do not any metal or conductor contact the terminal.
- Do not let the battery fall.If does,especially on the solid surface,please contact the service center.
- If there is any signs of Electrolyte leakage,do not let it get any direct contact with your bare skin or eyes.If it happened,use plenty of water to clean up or ask doctor for help.
- Do not uninstall the battery cell,or there will cause internal short even fire disaster or other issue.
- Do not burn the battery or throw it to the fire,otherwise,there will be cause the fire of the battery.